

# Dark Line | Line

Applicato nel canale Dark, si ottengono linee luminose ad alto e basso contrasto per luce generale.

*Applied in the Dark System, high and low contrast light lines are obtained for general lighting.*



### Track design

Questo è il risultato della filosofia "track design" introdotta nel 2018. Il canale Dark inserito nel cartongesso garantisce un percorso estetico e di luce dinamica, i prodotti interessati sono principalmente due: l'elemento lineare per la luce ambiente a basso contrasto e lo spot per luce puntuale, tutto alimentato a 48v con elettronica DALI.

*This is the result of the "track design" philosophy introduced in 2018. Dark system recessed in the plasterboard guarantees an aesthetic and dynamic light itinerary, the products involved are mainly two: the linear element for low-contrast ambient light and the spot for spot light, all powered at 48V with DALI dimming.*









me\_148 line

**DarkLine e Line** per profili Track  
Design come luce lineare ambiente.  
*Darkline and Line for Track Design as a linear  
ambient light.*

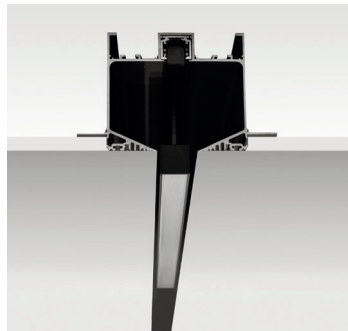

Sistema modulare per l'illuminazione lineare disponibile con diffusore in policarbonato opale o prismatico.

Tutti i moduli sono comprensivi di elettronica on/off \_ DALI per montaggio diretto nei profili Track Design 48v.

*Modular system for linear lighting available with opal or prismatic polycarbonate diffuser. All modules include on / off electronics \_ DALI for direct mounting in 48v Track Design profiles.*

## Dark line | Line

finitura darkline: nero.  
finishing darkline: black.

finiture line: nero, bianco.  
finishing line: black, white.

Adattatore 48v con innesto meccanico, flessibilità di agganciare e muovere il profilo in modo semplice e sicuro senza l'ausilio di alcun utensile.

*48v adapter with mechanic coupling, flexibility to install and remove the profile inside the lighting track in a simple and safe way without the use of any tools.*

### Diffusore - diffuser

Diffusore opale (efficienza 64%) o prismatico (efficienza 92%).

*Opal diffuser (efficiency 64%) or prismatic (92% efficiency).*

**Technical info:** pag. 387

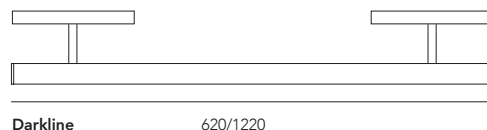

Darkline

620/1220

Dark

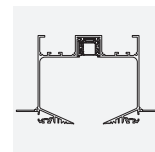

Compatibilità | Compatibility

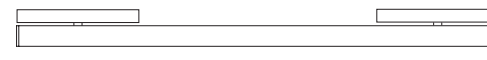

Line

620/1220

ME\_148



ME\_248

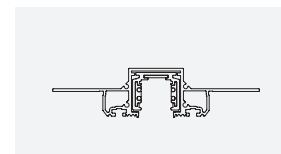

ME\_348

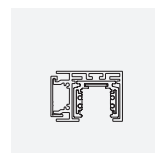

ME\_448

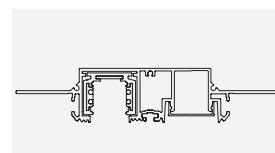

ME\_548

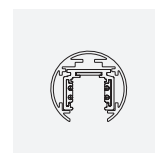

Compatibilità | Compatibility